

EN	Operating Instructions	56
----	------------------------	----

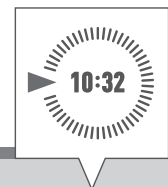

talento easy

C1 – Astro Timer

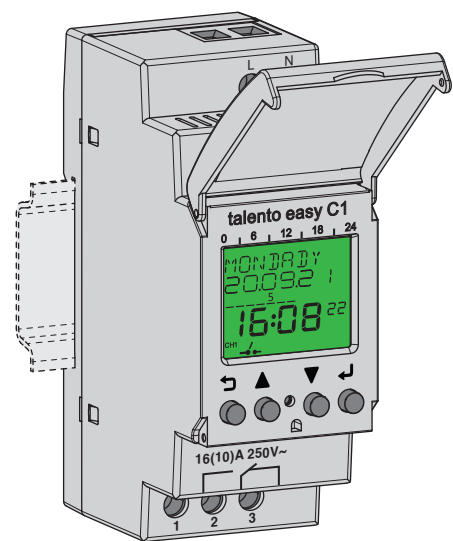

This manual ensures the safe and efficient use of the clock timer (referred to as “device” in the following). This manual is a component of the device and must remain accessible at all times for everyone who uses the device.

Everyone who uses the device must have read and understood this manual before commencing any work. The basic prerequisite for working safely is compliance with all safety instructions and usage instructions specified in this manual. Furthermore, the local accident prevention regulations and the general safety regulations in the area in which the device is operated apply.

Copyright

This manual is copyright protected.

Handover of this manual to third parties, reproductions of any type and form – including excerpts – and use and/or disclosure of the content without the written permission of the manufacturer, except for internal purposes, is not permitted. Violations will result in liability for damages. The manufacturer reserves the right to assert additional claims.





The copyright is held by the manufacturer.

Download

You can find the following information at www.graesslin.de:

- Download instructions
- Technical data



	Overview	59
	Design and function	59
	Operating modes.....	64
	Safety.....	66
	Installation	69
	Configuration.....	71
	Initial commissioning.....	71
	Setting the date and time	72
	Setting the time format	73
	Setting the date format	74
	Setting the first day of the week.....	75
	Setting the location information.....	76
	Activating/deactivating Twilight mode.....	78
	Selecting summer/winter time	79
	Selecting the operating mode.....	83
	Reading the operating hour counter.....	85
	Setting the backlight	88
	Setting a password	89
	Restoring to factory settings.....	90
	Device information	92
	Reading Astro time.....	93
	End menu	94
	Programming.....	95
	Creating a new Astro-switching program.....	95
	Viewing the Astro-switching program	98
	Modifying the Astro-switching program	99
	Deleting the Astro-switching program	100
	Deleting an individual Astro-switching program	100
	Deleting all Astro-switching programs	101



Creating a new holiday switching program 102
Activating the holiday switching program 103
Viewing the holiday switching program 104
Modifying the holiday switching program 105
Deleting the holiday switching program..... 106
 Deleting an individual holiday switching program 106
 Deleting all holiday switching programs 107



Disposal 108



Overview

Design and function

EN

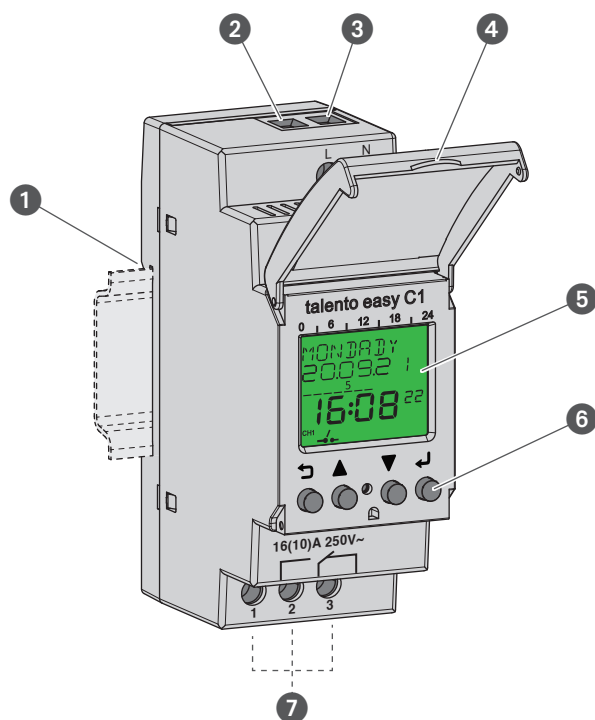

Fig. 1: Clock timer

- ① Click system for installation on a DIN rail
- ② Terminal for phase
- ③ Terminal for neutral conductor
- ④ Sealable housing
- ⑤ Display
- ⑥ Control buttons
- ⑦ Terminal for relay output

Description of function

The clock timer is a timer that is installed on a DIN rail (Fig. 1/①) by means of a click system; the timer controls the device that is connected via the output terminals (Fig. 1/⑦). The clock timer has one channel and can be operated via a display (Fig. 1/⑤) with four control buttons (Fig. 1/⑥).



Technical data (DIN EN 60730-1)

Mode of operation	1.B
Pollution degree	2
Rated impulse voltage	4000 V

The technical data for the devices described in this manual can be found at:
<https://graesslin.co.uk/product/talento-easy-c1/>

Possible uses

The following functions can be programmed on the clock timer:

- Date-independent programming
- Date-specific programming in the current year
- On, off programming
- Sunrise and sunset-specific programming



Display and control elements

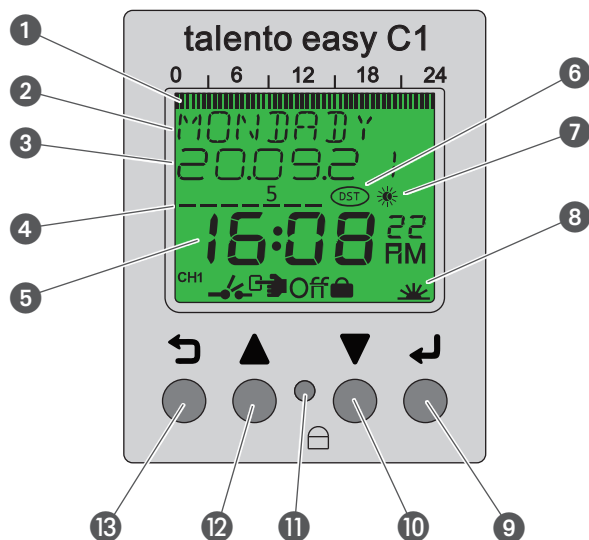

Fig. 2: Display layout

- ① Programmed switching times
- ② Day of the week or menu
- ③ Date
- ④ Day of the week
- ⑤ Time
- ⑥ Summer/winter
- ⑦ Day/night
- ⑧ Symbol bar
- ⑨ Enter button
- ⑩ Down button
- ⑪ Reset button
- ⑫ Up button
- ⑬ Menu button

Function buttons (Fig. 2/⑨ + ⑩)

Symbol	Designation	Function
	ESC	<ul style="list-style-type: none">• Open the main menu• Back to the main menu• Cancel without adopting changed values
	UP	<ul style="list-style-type: none">• Page up in the menu• Increase values
	DOWN	<ul style="list-style-type: none">• Page down in the menu• Reduce values



	ENTER	<ul style="list-style-type: none">• Make selection• Adopt
	RESET	Hardware reset The settings are not deleted.

EN

Button combinations

Symbol	Designation	Function
	ESC + UP	Override mode

Symbols (Fig. 2/6 + 7 + 8)

Symbol	Description
	Summer time
	Day time
	Night time
CH1	Channel 1
	The channel is switched on
	The channel is switched off
	Override mode active
On	Permanently ON (active)
Off	Permanently OFF (active)
	Holiday mode active
	Astro mode active



Menu structure

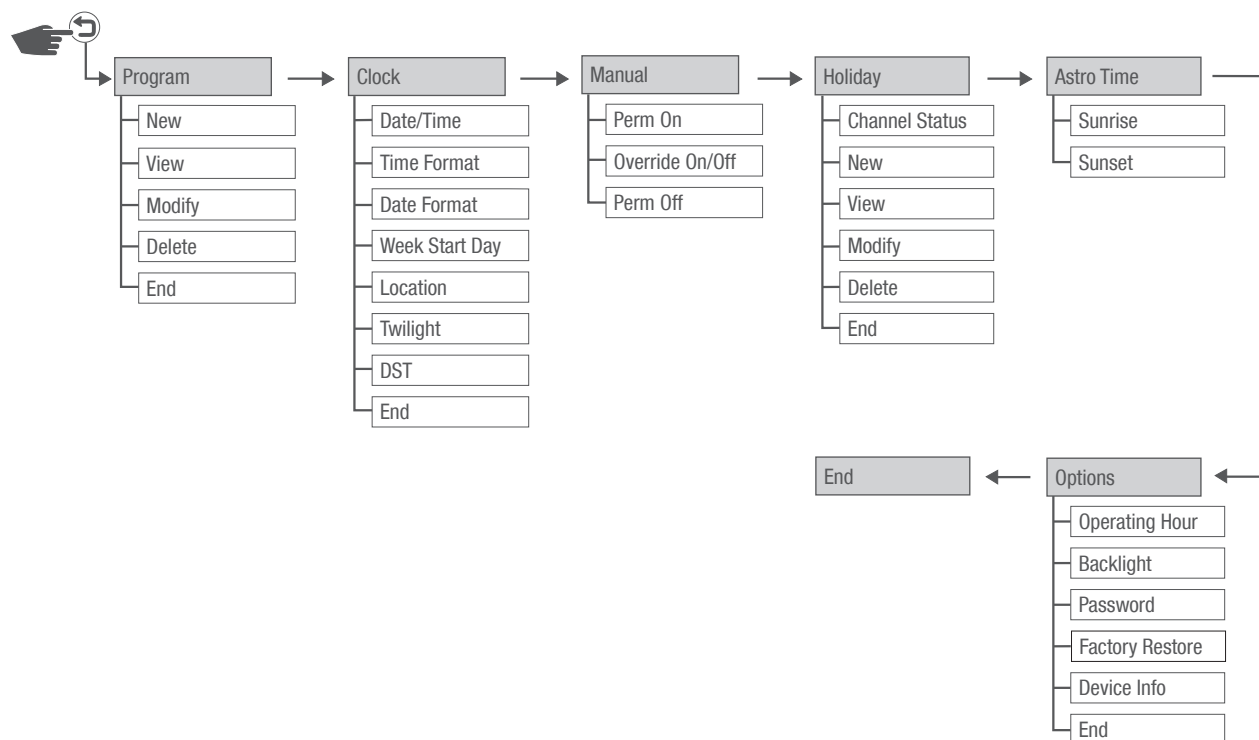

EN

Fig. 3: Menu structure

The menu structure appears on the display when you press the menu button  (Fig. 2/13).



If no button is pressed within 40 seconds while in programming mode, the device will exit programming mode.



Operating modes

Astro mode

In Astro mode, the channel is switched depending on sunrise and sunset. The values for this mode are recalculated on a daily basis.

For the description, see Chapter “Creating a new Astro-switching program” on page 95

Permanently ON

Channel is permanently switched on.

For the description, see Chapter “Permanently ON” on page 83

Permanently OFF

Channel is permanently switched off.

For the description, see Chapter “Permanently OFF” on page 84

Override mode

In override mode, the current program is temporarily overwritten. The override function only applies to the current program and remains active until the next automatic command. Then the device returns to automatic mode.

For the description, see Chapter “Override mode ON/OFF” on page 84

Holiday mode

With the holiday mode, the channel can be switched on or off for a defined period of time within one year.

For the description, see Chapter “Creating a new holiday switching program” on page 102



Priorities

When several programs are used, various switching commands can be present at the same time. Therefore, the channel is switched in accordance with the following priority:

1. Permanently ON/permanently OFF/override
2. Holiday mode ON
3. Holiday mode OFF
4. Astro mode OFF
5. Astro mode ON



Safety

EN

Safety instructions

Safety instructions are indicated in this manual by symbols. The safety instructions are introduced by signal words that express the extent of the danger.



WARNING!

This combination of symbol and signal word indicates a potentially dangerous situation that may result in death or severe injuries if the situation is not avoided.



CAUTION!

This combination of symbol and signal word indicates a potentially dangerous situation that may result in minor or slight injuries if the situation is not avoided.



NOTE!

This combination of symbol and signal word indicates a potentially dangerous situation that may result in material damage if the situation is not avoided.



**ENVIRONMENTAL
PROTECTION!**

This combination of symbol and signal word indicates potential dangers for the environment.

Tips and recommendations



This symbol highlights useful tips and recommendations, as well as information for efficient and fault-free operation.

Intended use

- The clock timer is intended solely for switching electric devices in private and commercial areas, provided this does not infringe on the intended use of these devices.
- The clock timer may only be installed on DIN rails.

The intended use also includes compliance with all information specified in this manual.



Any use other than the intended use is considered incorrect use. The legal warranty is voided by any interference with, or modifications to, the device.



WARNING!

Danger due to insufficient wire cross-section!

If wires with an insufficiently large cross-section are used, short circuits or fires may occur.

- Only use terminals with a cross-section between 0.5 mm² and 2.5 mm² for wires.



NOTE!

Damage to the clock timer due to incorrect installation location!

If installed in an unsuitable location, the clock timer may be damaged.

- Only use the clock timer in dry rooms and do not install close to devices with inductive discharge (motors, transformers, etc.).
- Only install the clock timer on DIN rails.

Residual risks

The device is state-of-the art and designed in accordance with current safety requirements. However, residual risks remain that require caution when using the device. The residual risks, and the conduct and measures they require, are listed in the following.

Electric current



WARNING!

Life-threatening danger from electric shock!

Improper assembly and installation of the device can lead to life-threatening electrical voltages.

- Only allow a qualified electrician to install and connect the device.



Personnel requirements

Qualified electrician

Professional training, knowledge and experience, and knowledge of the relevant standards and regulations allows the qualified electrician to perform work on electrical systems and to identify, and avoid, potential dangers of their own accord.

A qualified electrician is specifically trained for the work environment in which they work, and are familiar with the relevant standards and regulations.

Installation

Connecting the electricity

EN



WARNING!

Life-threatening danger from electric shock!

Improper assembly and installation of the device can lead to life-threatening electrical voltages.

- Only allow a qualified electrician to install and connect the device.

Personnel:

- Qualified electrician

Materials:

- DIN rail (15 mm x 7.5 mm)
- DIN rail (15 mm x 12.5 mm)

Prerequisite:

- The terminals for the wires must have a cross-section between 0.5 mm² and 2.5 mm².

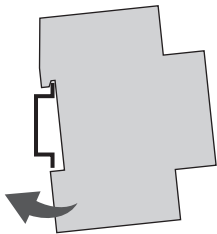

Fig. 4: Installation on a DIN rail

1. Place the clock timer on the DIN rail (Fig. 4) from above and press it back until it locks into place.
2. Strip the insulation from the wires.
 - Stripping length: 8 mm



NOTE!

Tightening torques

To avoid damage and faulty contacts, tighten the terminals using a torque of 0.5 Nm.

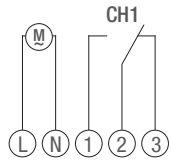

Fig. 5: Circuit diagram

3. Connect the clock timer in accordance with the circuit diagram (Fig. 5).



Configuration

Back-up battery

EN



NOTE!

Reduced power reserve in the back-up battery!

After six years of storage without being connected to the mains, the back-up battery will be fully discharged.

Initial commissioning



The programming of the clock timer may only be carried out after connecting it to an external power supply.

Condition on delivery

When delivered, the device is in automatic mode with default settings for the date and time.





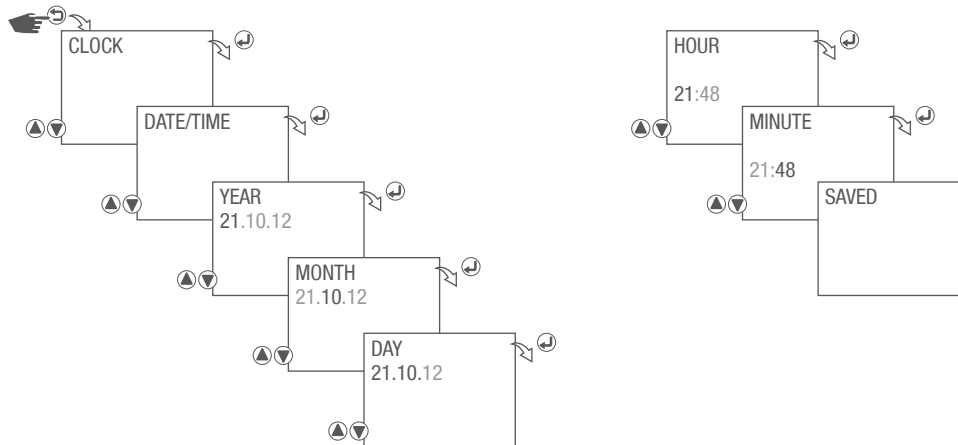





Setting the date and time



EN

Fig. 6: Setting the date and time

1. Press the  button.
2. Select **CLOCK** and confirm with the  button.
3. Select **DATE/TIME** and confirm with the  button.
4. Set the year and confirm with the  button.
5. Set the month and confirm with the  button.
6. Set the day and confirm with the  button.
7. Set the hours and confirm with the  button.
8. Set the minutes and confirm with the  button.
9. The settings will be adopted.



Setting the time format

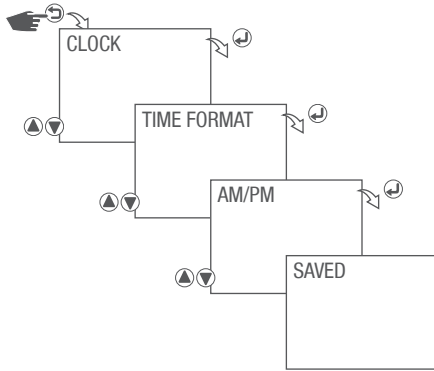





Fig. 7: Setting the time format

1. Press the  button.
2. Select **CLOCK** and confirm with the  button.
3. Select **TIME FORMAT** and confirm with the  button.
4. Select time format and confirm with the  button.

Setting	Effect
24 hours	The time is displayed in a 24-hour format.
AM/PM	The time is displayed in a 12-hour format. <ul style="list-style-type: none">• AM = morning• PM = afternoon

5. The settings will be adopted.





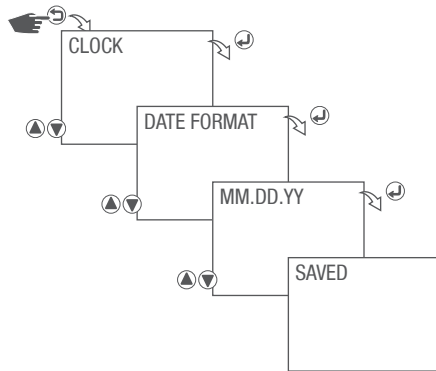

Setting the date format



EN

Fig. 8: Setting the date format

1. Press the  button.
2. Select **CLOCK** and confirm with the  button.
3. Select **DATE FORMAT** and confirm with the  button.
4. Select date format and confirm with the  button.

Setting	Effect
DD:MM:YY	Example: 13.10.21
MM:DD:YY	Example: 10.13.21
YY:MM:DD	Example: 21.10.13

5. The settings will be adopted.



Setting the first day of the week

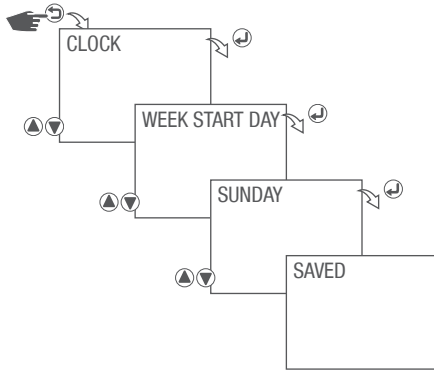





Fig. 9: Setting the first day of the week

1. Press the  button.
2. Select **CLOCK** and confirm with the  button.
3. Select **WEEK START DAY** and confirm with the  button.
4. Select the first day of the week (Saturday to Sunday) and confirm with the  button.
5. The settings will be adopted.



Selecting the day of the week

Example:

- 1st day = Sunday... 1 – 5 = Sun – Thu
- 1st day = Monday... 1 – 5 = Mon – Fri



Setting the location information

The location information is required by the Astro function. Once the location has been specified, the programs can adjust to sunrise and sunset at the location in question. The location information can be set using the desired country and a city. Alternatively, the exact location coordinates may also be used. The last entered setting has the top priority.

EN

Setting the country and city

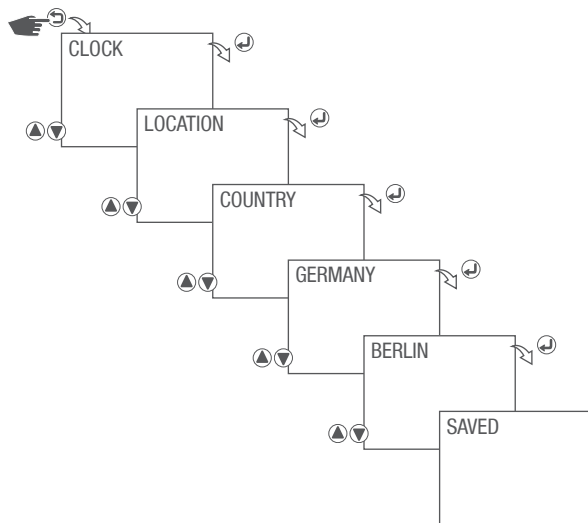





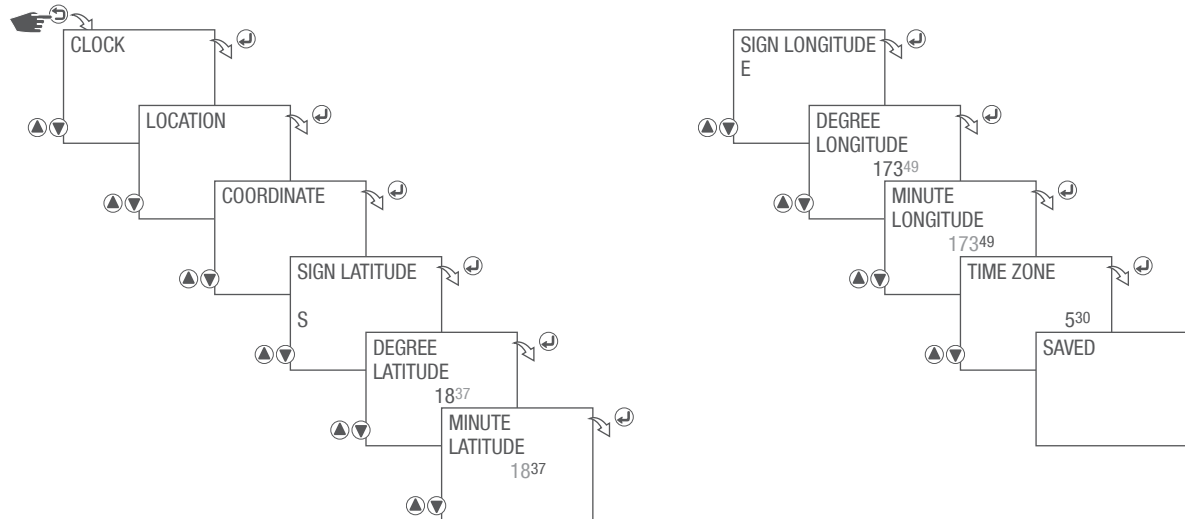

Fig. 10: Setting the country and city

1. Press the  button.
2. Select **CLOCK** and confirm with the  button.
3. Select **LOCATION** and confirm with the  button.
4. Select **COUNTRY** and confirm with the  button.
5. Select country and confirm with the  button.
6. Select city and confirm with the  button.
7. The settings will be adopted.



Setting the location coordinates



EN

Fig. 11: Setting the location coordinates

1. Press the button.
2. Select **CLOCK** and confirm with the button.
3. Select **LOCATION** and confirm with the button.
4. Select **COORDINATE** and confirm with the button.
5. Select the direction (north or south) of the latitude and confirm with the button.
6. Set the latitude and confirm with the button.
7. Set the minutes and confirm with the button.
8. Select the direction (east or west) of the longitude and confirm with the button.
9. Set the longitude and confirm with the button.
10. Set the minutes and confirm with the button.
11. Set the time zone and confirm with the button.
12. The settings will be adopted.



Activating/deactivating Twilight mode

Sufficient ambient light is available even after sunset. Because of this, it is not necessary to switch the channel on precisely at sunset for certain applications (e.g. exterior lights). With the Twilight function, the channel is switched on after a delay. This time period is calculated automatically.

EN

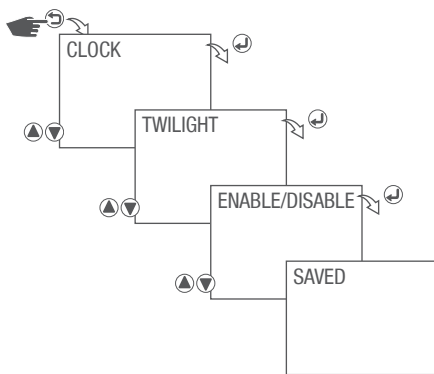

Fig. 12: Activating/deactivating Twilight mode

1. Press the button.
2. Select **CLOCK** and confirm with the button.
3. Select **TWILIGHT** and confirm with the button.
4. Activate/deactivate Twilight mode and confirm with the button.

Setting	Effect
ENABLE	Twilight mode active
DISABLE	Twilight mode deactivated.

5. The settings will be adopted.



Selecting summer/winter time

The summer/winter time (summer time = DST – Daylight Saving Time) can be automatically calculated in accordance with the following possible settings. The last entered setting has the top priority.

EN



In order to prevent accidental adjustments when changing the day, the time adjustment range is locked from 9.01 PM - 11.59 PM.

No summer time

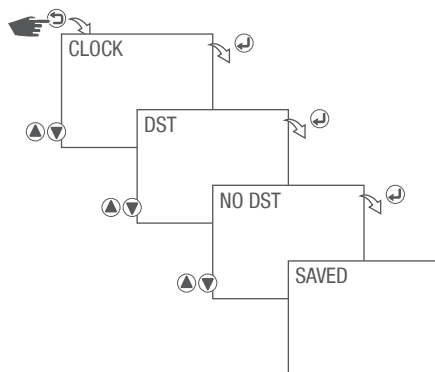





Fig. 13: No summer time

1. Press the  button.
2. Select **CLOCK** and confirm with the  button.
3. Select **DST** and confirm with the  button.
4. Select **NO DST** and confirm with the  button.
5. The settings will be adopted.



Setting fixed summer time

The change is carried out in accordance with the set date and time with an offset of 1 hour (corrective value).

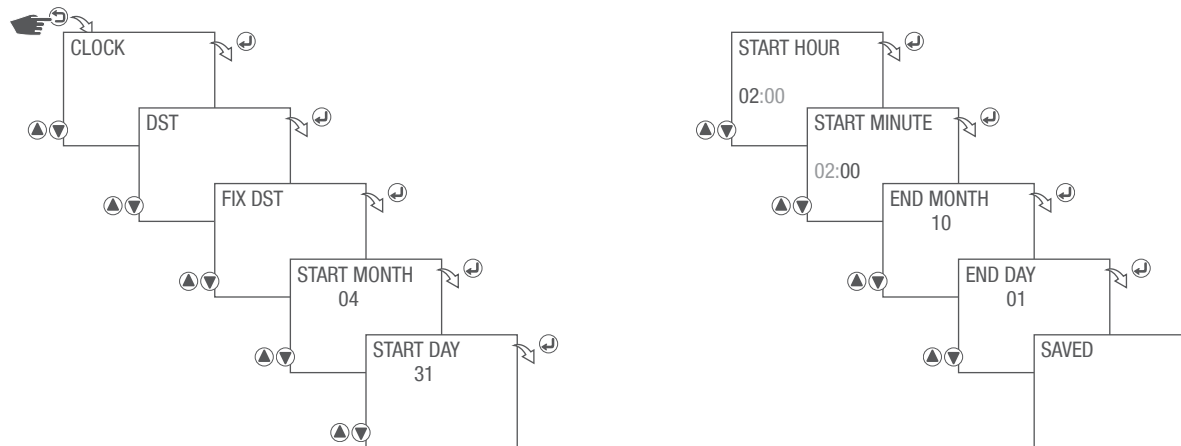

Fig. 14: Setting fixed summer time

1. Press the button.
2. Select **CLOCK** and confirm with the button.
3. Select **DST** and confirm with the button.
4. Select **FIX DST** and confirm with the button.
5. Set start month and confirm with the button.
6. Set start day and confirm with the button.
7. Set start hours and confirm with the button.
8. Set start minutes and confirm with the button.
9. Set end month and confirm with the button.
10. Set end day and confirm with the button.
11. The settings will be adopted.



Setting customer-specific summer time

The change is carried out in accordance with the set date and time. The offset range (corrective value) can be set from 1 minute to 2 hours.

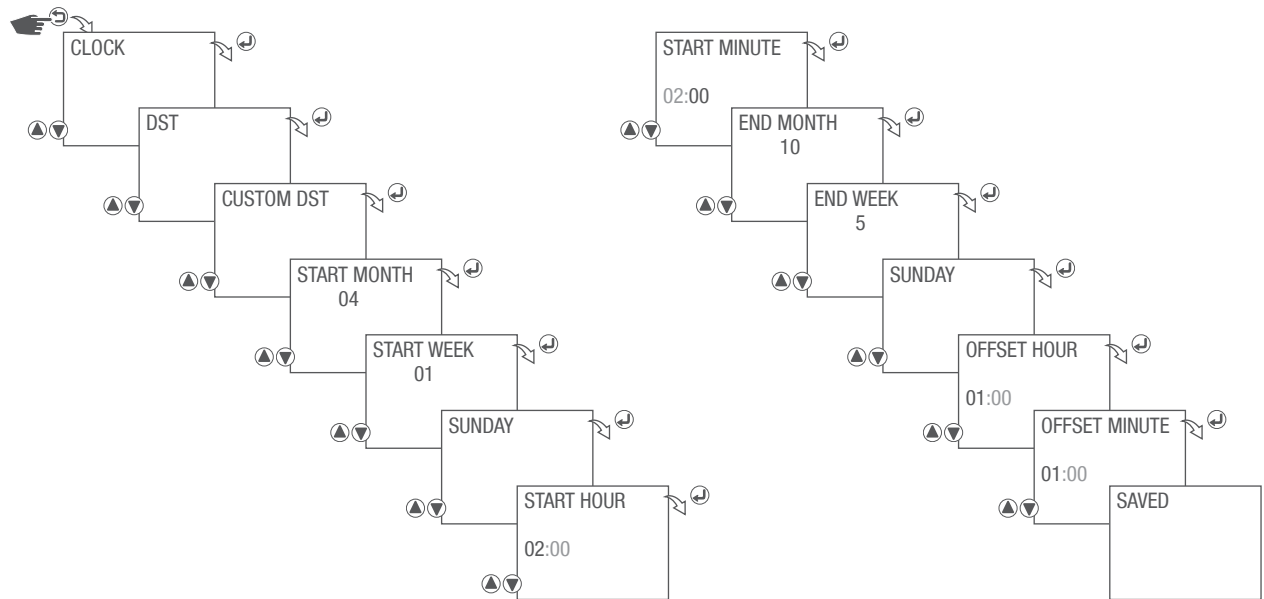

Fig. 15: Setting customer-specific summer time

1. Press the button.
2. Select **CLOCK** and confirm with the button.
3. Select **DST** and confirm with the button.
4. Select **CUSTOM DST** and confirm with the button.
5. Set start month and confirm with the button.
6. Set start week and confirm with the button.
7. Set start day and confirm with the button.
8. Set start hours and confirm with the button.
9. Set start minutes and confirm with the button.
10. Set end month and confirm with the button.
11. Set end week and confirm with the button.
12. Set end day and confirm with the button.
13. Set offset hours and confirm with the button.
14. Set offset minutes and confirm with the button.
15. The settings will be adopted.



Setting summer time in accordance with the table of countries

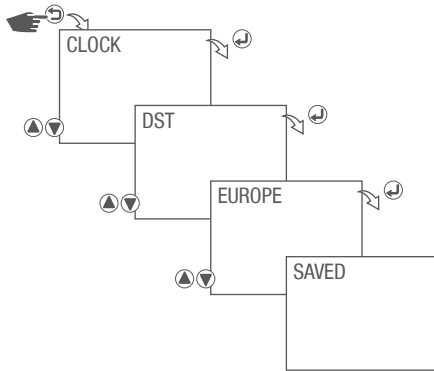

Fig. 16: Setting summer time in accordance with the table of countries

1. Press the button.
2. Select **CLOCK** and confirm with the button.
3. Select **DST** and confirm with the button.
4. Select country and confirm with the button.
5. The settings will be adopted.

Summer time - table of countries

Country	Start month	Start week	Start day	Start time	End month	End week	End day	End time	Offset time
Europe	March	Last week	Sunday	2:00	October	Last week	Sunday	3:00	1:00
USA	March	2nd week	Sunday	2:00	November	1st week	Sunday	3:00	1:00
GB/IRL/P	March	Last week	Sunday	1:00	October	Last week	Sunday	2:00	1:00
FIN/GR/TR	March	Last week	Sunday	3:00	October	Last week	Sunday	4:00	1:00
CDN	April	1st week	Sunday	2:00	October	Last week	Sunday	3:00	1:00



Selecting the operating mode

In this menu, different operating modes can be activated or deactivated. The last entered setting has the top priority.

When the operating modes are deactivated, the clock timer is in automatic mode.

Possible settings

ON	Permanently ON	Channel is permanently switched on.
Off	Permanently OFF	Channel is permanently switched off.
	Override mode ON	In override mode, the current program is temporarily overwritten. <ul style="list-style-type: none">Start a program early that is set to start later with "Override mode ON". The override function only applies to the current program and remains active until the next automatic command. Then the device returns to automatic mode.

Example:

A daily program switches the device on every day from 8:00 a.m. to 5:00 p.m. If, however, you want the device to be on at 6:00 a.m. on a certain day, use the override mode.

Permanently ON

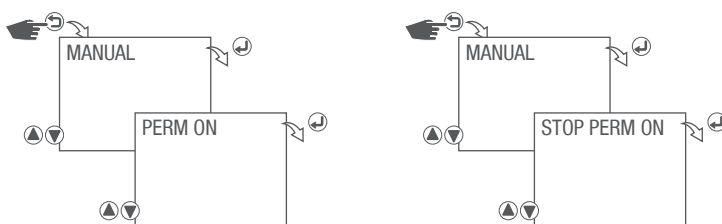

Fig. 17: Permanently ON operating mode

1. Press the button.
2. Select **MANUAL** and confirm with the button.
3. Confirm **PERM ON** with the button to start the permanently ON operating mode.
4. To end the permanently ON operating mode, confirm **STOP PERM ON** with the button.



Permanently OFF

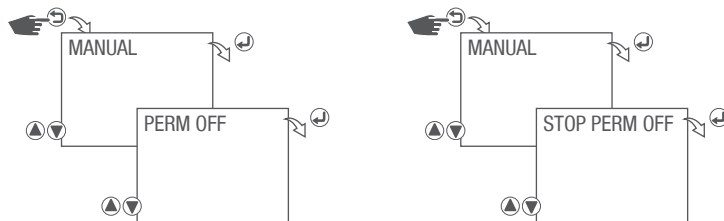





Fig. 18: Permanently OFF operating mode

1. Press the  button.
2. Select **MANUAL** and confirm with the  button.
3. Confirm **PERM OFF** with the  button to start the permanently OFF operating mode.
4. To end the permanently OFF operating mode, confirm **STOP PERM OFF** with the  button.

Override mode ON/OFF

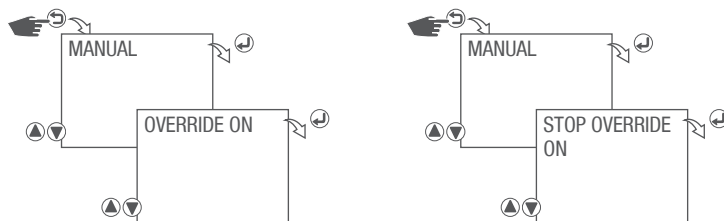





Fig. 19: Switching the override mode on/off

1. Press the  button.
2. Select **MANUAL** and confirm with the  button.
3. Confirm **OVERRIDE ON** with the  button to start the override operating mode.
4. To end the override operating mode, confirm **STOP OVERRIDE ON** with the  button.



Reading the operating hour counter

Reading the operating hour counter

EN

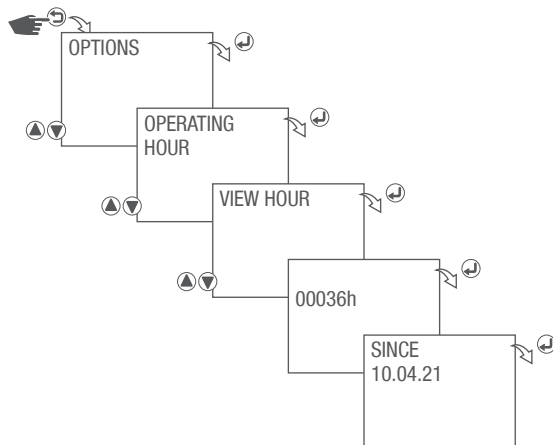







Fig. 20: Reading the operating hour counter

1. Press the  button.
2. Select **OPTIONS** and confirm with the  button.
3. Select **OPERATING HOUR** and confirm with the  button.
4. Select **VIEW HOUR** and confirm with the  button. The operating hours will be displayed.
5. Pressing the  button again displays when the operating hour counter was started.



Deleting the operating hour counter

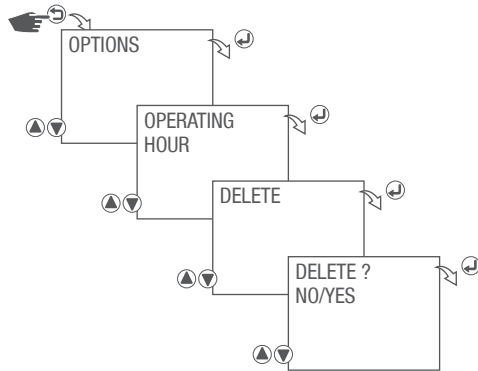

Fig. 21: Deleting the operating hour counter

1. Press the button.
2. Select **OPTIONS** and confirm with the button.
3. Select **OPERATING HOUR** and confirm with the button.
4. Select **DELETE** and confirm with the button.
5. Select whether or not the operating hour counter is to be deleted and confirm with the button.

Setting	Effect
NO	The operating hour counter continues to count.
YES	The operating hour counter is reset.



Setting the service alarm

It is possible to display an alarm message once a preset number of operating hours has been reached.

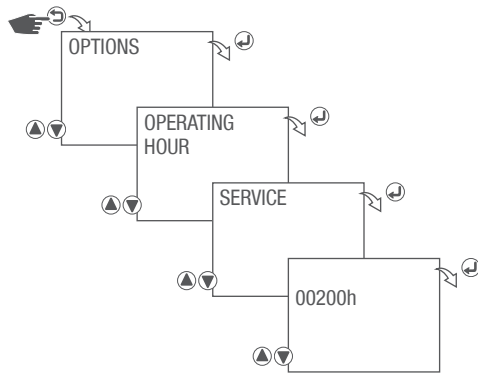







Fig. 22: Setting the service alarm

1. Press the  button.
2. Select **OPTIONS** and confirm with the  button.
3. Select **OPERATING HOUR** and confirm with the  button.
4. Select **SERVICE** and confirm with the  button.
5. Enter the number of operating hours, after which an alarm will be displayed. Confirm with the  button.



The alarm message will be shown in the display as text.



Setting the backlight

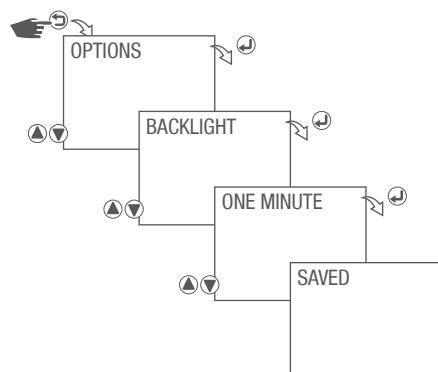

Fig. 23: Setting the backlight

1. Press the button.
2. Select **OPTIONS** and confirm with the button.
3. Select **BACKLIGHT** and confirm with the button.
4. Select the type of backlight and confirm with the button.

Setting	Effect
ONE MINUTE	The backlight of the display remains on for one minute after the last button press.
CONTINUOUS ON	The backlight of the display remains on continuously.

5. The settings will be adopted.



Setting a password

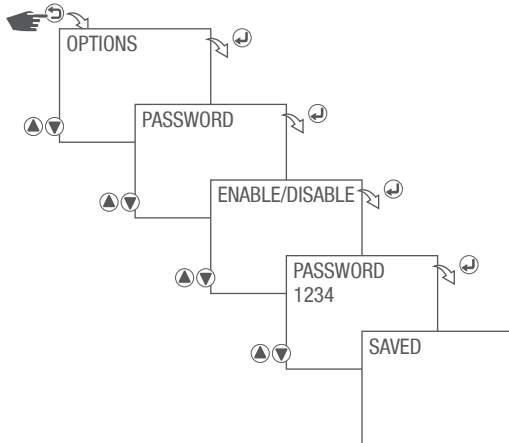







Fig. 24: Setting a password

1. Press the  button.
2. Select **OPTIONS** and confirm with the  button.
3. Select **PASSWORD** and confirm with the  button.
4. Select **PASSWORD ENABLE** and confirm with the  button.
5. Enter password and confirm with the  button.
6. The settings will be adopted.



A four-digit numerical code can be entered as a password.

After the password has been confirmed, the clock timer will then be protected by it. The menu can only be accessed by entering the password correctly.

The clock timer will be automatically password-protected once more 40 seconds after the last button press.

Disabling password protection:

After entering the correct password in the password menu, select **DISABLE** and confirm with the  button.

Forgotten your password?

Master password for activation available from:

Technical Support: +49 7724 933 500 or via email: support@graesslin.de



Restoring to factory settings



All settings, apart from the date and time, will be restored to the original factory settings.

EN

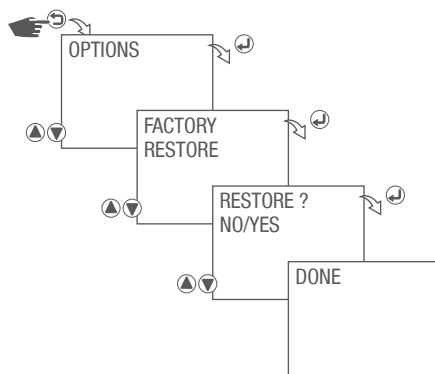

Fig. 25: Restoring to factory settings

1. Press the button.
2. Select **OPTIONS** and confirm with the button.
3. Select **FACTORY RESTORE** and confirm with the button.
4. Select whether or not the clock timer is to be restored to the factory settings and confirm with the button.

Setting	Effect
NO	Cancel – restoring to factory settings is not started.
YES	The clock timer is reset to the factory settings.

5. The corresponding action is carried out and displayed.



Factory settings

Setting	Effect
Time format	24 h
Date format	DD:MM:YY
First day of the week	Sunday
Twilight mode	Deactivated
Summer time	No summer time
Holiday mode	Deactivated
Backlight	1 minute
Password	Deactivated





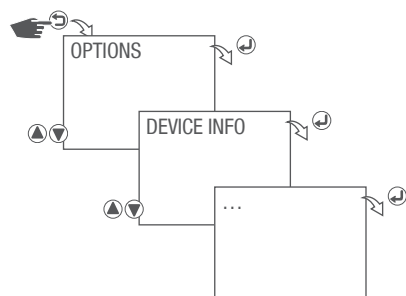

Device information



EN

Fig. 26: Device information

1. Press the  button.
2. Select **OPTIONS** and confirm with the  button.
3. Select **DEVICE INFO** and confirm with the  button.
4. Press the  button to go to the next device information.

Info	Description
TALENTO EASY C1 XXXX	Device name, XXXX = firmware version
MANUFACTURE ON	Date of manufacture (date on which the firmware was installed on the device)
ON BATTERY HRS	Total time since manufacture that the device has been running in battery mode
ON MAINS HRS	Total time since manufacture that the device has been connected to the mains
FIRST MAINS	Date and time on which the device was connected for the first time after manufacture
TEMPERATURE	Temperature in device
RTC.CONST	Manufacturer-specific information
RL X.XX.XX	Manufacturer-specific specification
LAST EDIT DATE	Date and time on which the date and time were last set



Reading Astro time

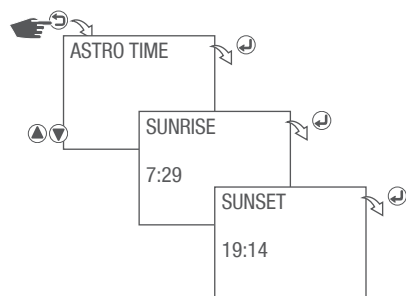

Fig. 27: Reading Astro time

5. Press the button.
6. Select **ASTRO TIME** and confirm with the button.
7. The sunrise time will be displayed.
8. The sunset time will be displayed following confirmation with the button.



End menu

End menu appears in several places in the menu navigation, e.g. the main menu, program, clock, holiday and options. It is used to close the menu and return to the start screen.

EN

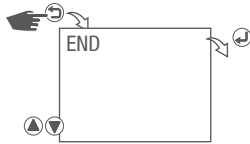

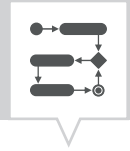

Fig. 28: End menu

1. Press the  button.
2. Select END and confirm with the  button.



Programming



The programming of the clock timer may only be carried out after connecting it to an external power supply.

Creating a new Astro-switching program



Up to 50 Astro-switching programs may be created.

Example: sunset – sunrise

The channel is switched on upon sunset from Monday to Sunday without offset.

However, the channel should not be switched on for the duration of the entire night. The exterior lighting is switched off when the OFF hours start at 11:00 p.m.

The exterior lighting is switched back on when the OFF hours end at 5:30 a.m. The exterior lighting remains switched on until sunrise.

The automatic switching program should be run annually from 03/01 to 09/30.

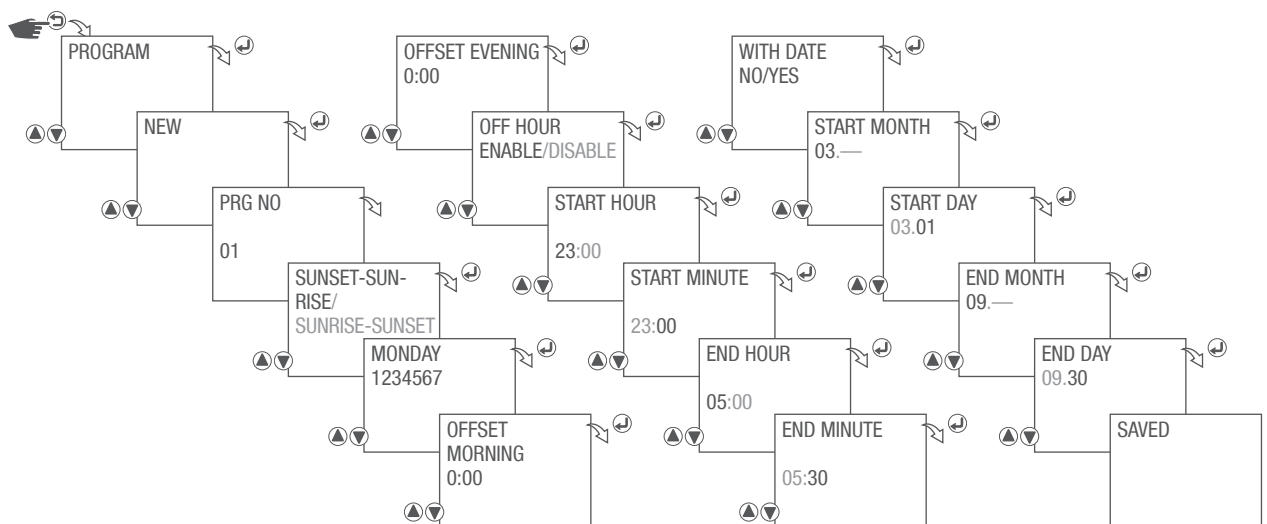
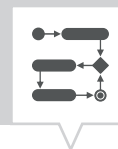

Fig. 29: Creating a new Astro-switching program



1. Press the button.
2. Select **PROGRAM** and confirm with the button.
3. Select **NEW** and confirm with the button.
4. The automatically assigned program number will be displayed briefly.
5. Select **SUNSET-SUNRISE** or **SUNRISE-SUNSET** and confirm with the button.



The sunrise and sunset times are calculated automatically.

Setting	Effect
SUNSET-SUNRISE	The channel is switched on from sunset to sunrise.
SUNRISE-SUNSET	The channel is switched on from sunrise to sunset.

6. - select day(s) of the week on which the switching program is to be carried out and confirm with the button.



The days of the week 1 – 7 are set by default. Individual days of the week can be set as follows:

Days of the week can be selected with the button.

Days of the week can be deselected with the button.

7. Set **OFFSET MORNING** and confirm with the button.
8. Set **OFFSET EVENING** and confirm with the button.







The offset range (corrective value) can be set from -2 to +2 hours.

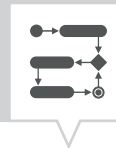



9. Select **OFF HOUR ENABLE** and confirm with the button. Selecting **DISABLE** skips this function.

Entry	Result
OFF HOUR DISABLE	The OFF hour function is not activated.
OFF HOUR ENABLE	The OFF hour function is activated.



- 10. Start time – select hours and confirm with the  button.
- 11. Start time – select minutes and confirm with the  button.
- 12. End time – select hours and confirm with the  button.
- 13. End time – select minutes and confirm with the  button.
- 14. Select **WITH DATE YES** and confirm with the  button. Selecting **NO** skips this function.

Option	Entry	Result
Program the Clock timer without a date range.	NO	The switching commands are valid independently of the date.
Program the Clock timer with a date range.	YES	The switching commands are valid for the days or periods that are defined in the programming.

- 15. Start date – select month and confirm with the  button.
- 16. Start date – select day and confirm with the  button.
- 17. End date – select month and confirm with the  button.
- 18. End date – select day and confirm with the  button.
- 19. The settings will be adopted.

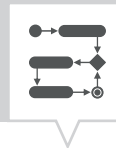

Viewing the Astro-switching program

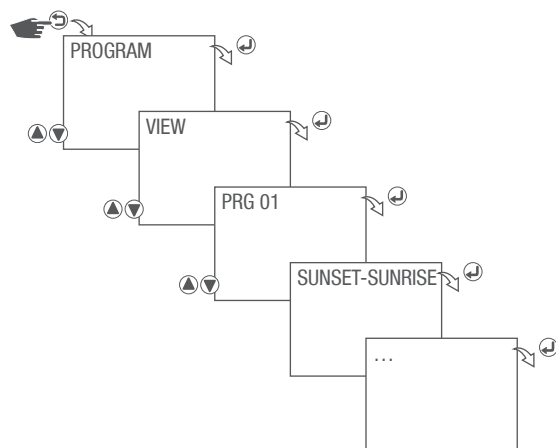

EN

Fig. 30: Viewing the Astro-switching program

1. Press the button.
2. Select **PROGRAM** and confirm with the button.
3. Select **VIEW** and confirm with the button.
4. Select program number and confirm with the button.
5. Press the for the next program section.

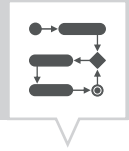

Modifying the Astro-switching program

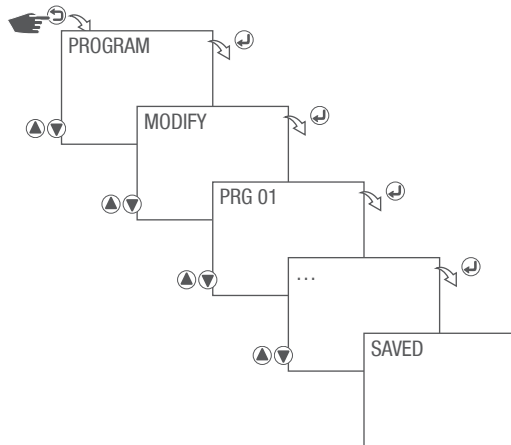
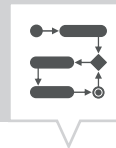

Fig. 31: Modifying the Astro-switching program

1. Press the button.
2. Select **PROGRAM** and confirm with the button.
3. Select **MODIFY** and confirm with the button.
4. Select program number and confirm with the button.
5. Modify the program. Procedure Chapter “Creating a new Astro-switching program” on page 95.



Deleting the Astro-switching program

DELETING AN INDIVIDUAL ASTRO-SWITCHING PROGRAM

EN

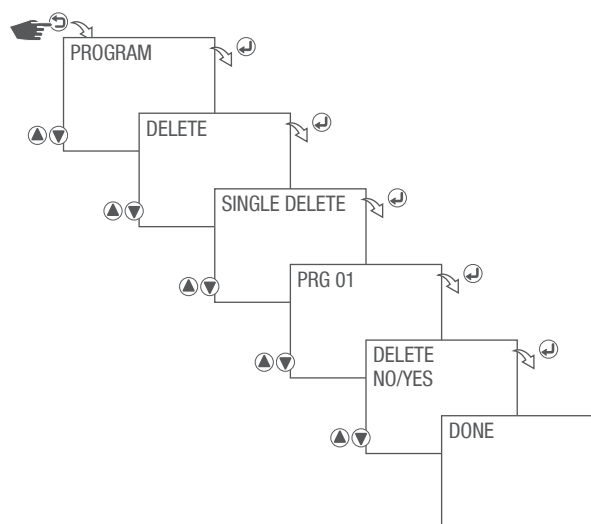
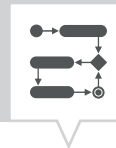

Fig. 32: Deleting an individual Astro-switching program

1. Press the button.
2. Select **PROGRAM** and confirm with the button.
3. Select **DELETE** and confirm with the button.
4. Select **SINGLE DELETE** and confirm with the button.
5. Select program number and confirm with the button.
6. Select whether or not the selected Astro-switching program is to be deleted and confirm with the button.

Setting	Effect
NO	Cancel – the selected Astro-switching program is not deleted.
YES	The selected Astro-switching program is deleted.

7. The corresponding action is carried out and displayed.



DELETING ALL ASTRO-SWITCHING PROGRAMS

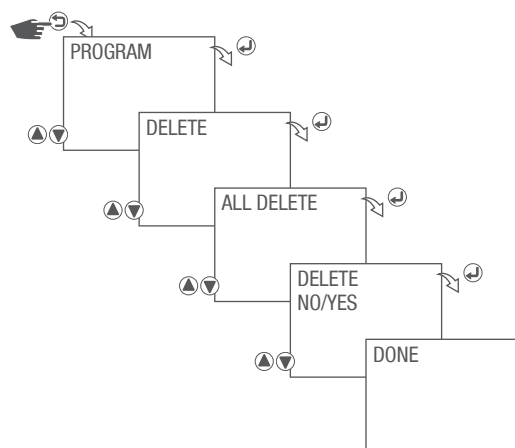

EN

Fig. 33: Deleting an individual Astro-switching program

1. Press the button.
2. Select **PROGRAM** and confirm with the button.
3. Select **DELETE** and confirm with the button.
4. Select **ALL DELETE** and confirm with the button.
5. Select whether or not all Astro-switching programs are to be deleted and confirm with the button.

Setting	Effect
NO	Cancel – the Astro-switching programs are not deleted.
YES	All Astro-switching programs are deleted.

6. The corresponding action is carried out and displayed.

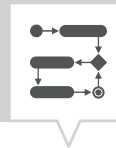

Creating a new holiday switching program



Up to 10 switching programs may be created.

The channel can be switched on or off for the duration of a holiday.

The holiday program must be activated in order for it to be carried out, see Chapter “Activating the holiday switching program” on page 103.

EN

Example

The channel is switched on from 7/30/2021 at 12:00 p.m. to 6:00 p.m. on 9/12/2021.

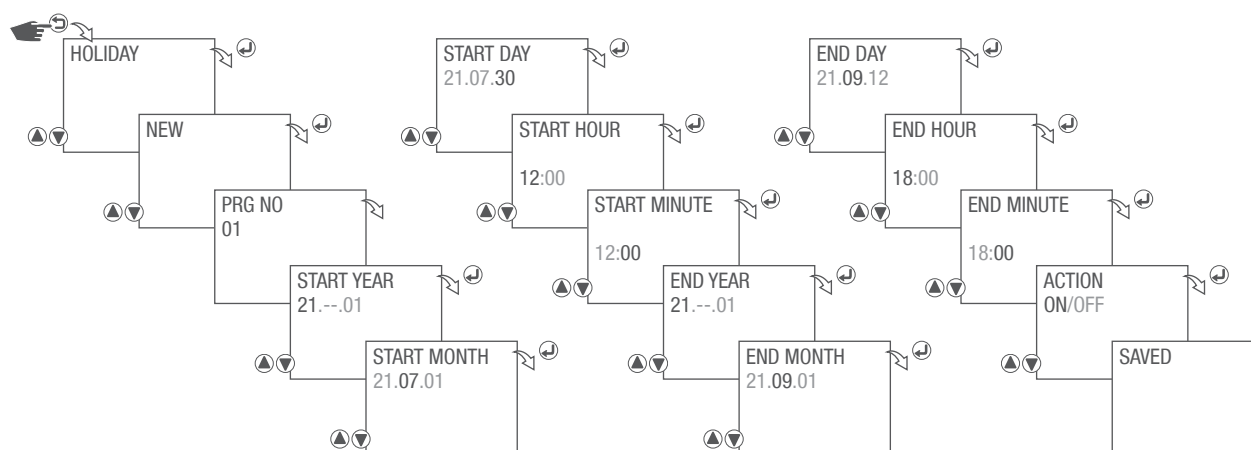
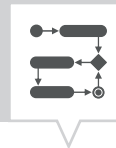





Fig. 34: Creating a new holiday switching program

1. Press the button.
2. Select **HOLIDAY** and confirm with the button.
3. Select **NEW** and confirm with the button.
4. The automatically assigned program number will be displayed briefly.
5. Start date – select year and confirm with the button.
6. Start date – select month and confirm with the button.
7. Start date – select day and confirm with the button.
8. Start time – select hours and confirm with the button.
9. Start time – select minutes and confirm with the button.
10. End date – select year and confirm with the button.



11. End date – select month and confirm with the  button.
12. End date – select day and confirm with the  button.
13. End time – select hours and confirm with the  button.
14. End time – select minutes and confirm with the  button.
15. **ACTION ON** – select to switch the channel to the set time period.

Entry	Result
ON	The channel is switched on.
OFF	The channel is switched off.

16. The settings will be adopted.

Activating the holiday switching program

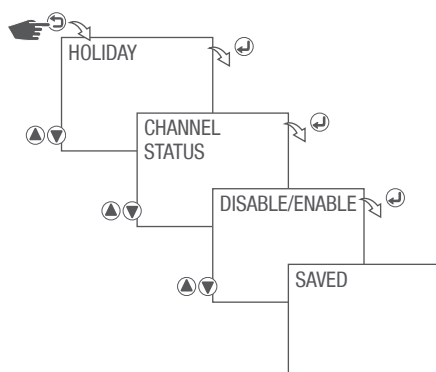



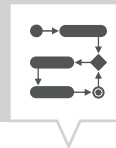

Fig. 35: Activating the holiday switching program

1. Press the  button.
2. Select **HOLIDAY** and confirm with the  button.
3. Select **CHANNEL STATUS** and confirm with the  button.
4. Select whether or not the holiday switching program is to be activated.

Entry	Result
DISABLE	The holiday switching program is not activated.
OFF	The holiday switching program is activated.

5. The settings will be adopted.



Viewing the holiday switching program

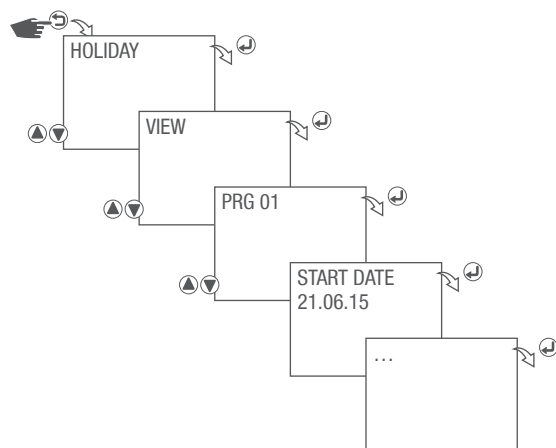
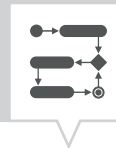

Fig. 36: Viewing the holiday switching program

1. Press the button.
2. Select **PROGRAM** and confirm with the button.
3. Select **VIEW** and confirm with the button.
4. Select program number and confirm with the button.
5. Press the for the next program section.



Modifying the holiday switching program

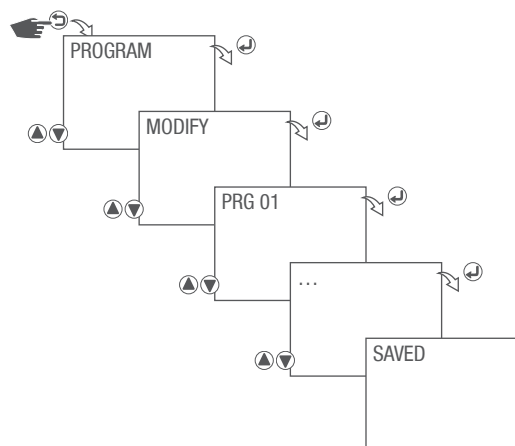
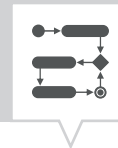

Fig. 37: Modifying the holiday switching program

1. Press the button.
2. Select **PROGRAM** and confirm with the button.
3. Select **MODIFY** and confirm with the button.
4. Select program number and confirm with the button.
5. Modify the program. Procedure Chapter “Creating a new holiday switching program” on page 102.



Deleting the holiday switching program

DELETING AN INDIVIDUAL HOLIDAY SWITCHING PROGRAM

EN

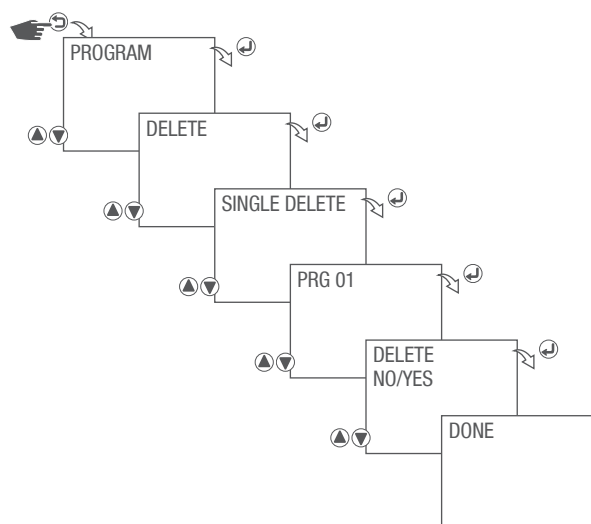
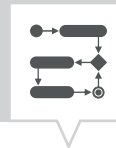

Fig. 38: Deleting an individual holiday switching program

1. Press the button.
2. Select **PROGRAM** and confirm with the button.
3. Select **DELETE** and confirm with the button.
4. Select **SINGLE DELETE** and confirm with the button.
5. Select program number and confirm with the button.
6. Select whether or not the selected switching program is to be deleted and confirm with the button.

Setting	Effect
NO	Cancel – the selected switching program is not deleted.
YES	The selected switching program is deleted.

7. The corresponding action is carried out and displayed.



DELETING ALL HOLIDAY SWITCHING PROGRAMS

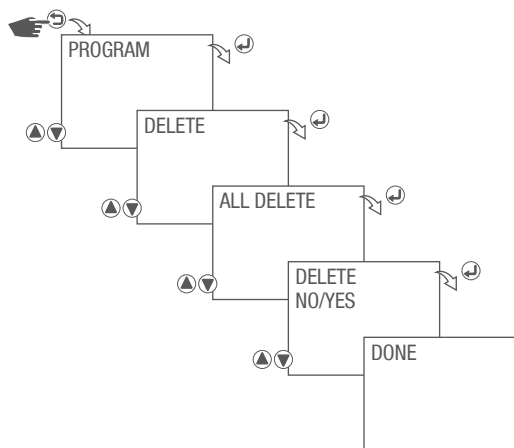

Fig. 39: Deleting all holiday switching programs

1. Press the button.
2. Select PROGRAM and confirm with the button.
3. Select DELETE and confirm with the button.
4. Select ALL DELETE and confirm with the button.
5. Select whether or not all switching programs are to be deleted and confirm with the button.

Setting	Effect
NO	Cancel – the switching programs are not deleted.
YES	All switching programs are deleted.

6. The corresponding action is carried out and displayed.



Disposal



ENVIRONMENTAL PROTECTION!

Incorrect disposal presents an environmental danger.

Incorrect disposal could result in environmental dangers.

- Correct disposal helps to protect the environment and prevents humans and the environment from potential harm.



When disposing of the device, the pertinent legal requirements must be observed.

Information regarding the disposal of electrical and electronic devices within the European Union:

Within the European Union, the disposal of electrically powered appliances is governed by national regulations which are based on EU Directive 2012/19/EU on waste electrical and electronic equipment (WEEE). The device can thereafter no longer be disposed of with municipal solid waste or household waste. The device is accepted free of charge at local collection points or recycling centers. The product packaging is made of recyclable materials. These must be disposed of in an environmentally friendly manner and recycled.

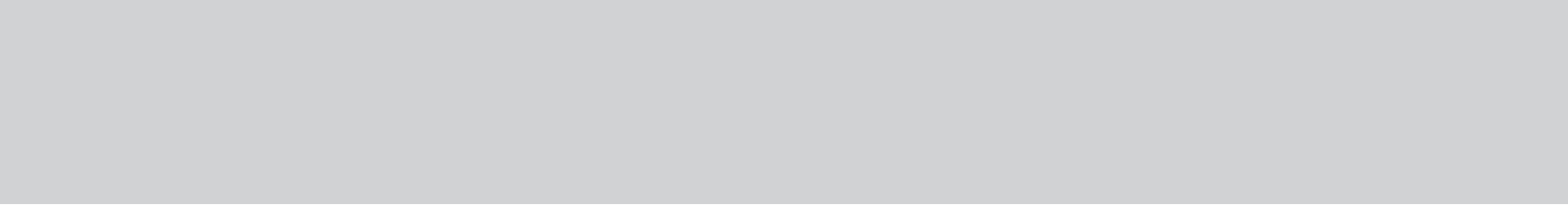

GRÄSSLIN

Grässlin Zeitschalttechnik GmbH

Leopoldstr. 1

78112 St. Georgen

Germany

+49 7724 933-0

+49 7724 933-240

info@graesslin.de

www.graesslin.de