



Garage Door Operators

Intelligent, German operators that **revolutionises** the garage door industry

What makes SOMMER's operators so powerful is the ingenious technology. These motors are not statically fixed to one point; they travel along a stationary, tensioned chain, providing the optimal application of force with maximum safety at all times.

Smooth-running & long-lasting

Thanks to the gear-saving technology, the garage door operator is extremely quiet, low-wear and has a very long lifetime.



Direct Drive Technology

Provides quiet, smooth & reliable operation via a gear-less design, where the operator drives the door directly, eliminating the need for chains or belts

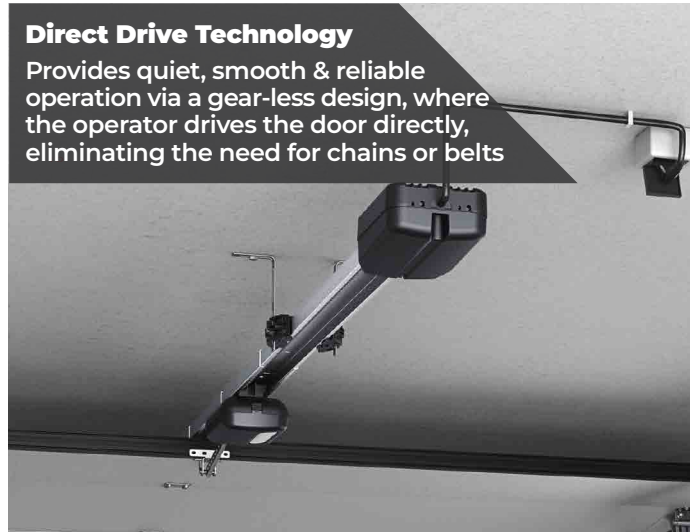

Motor carriage with integrated LED Lighting



Easy to Install Accessories

The comprehensive accessory range offer easy installation via colour coding & a plug & play design



Environmental Friendly: In power saving mode, consumption is less than 1 watt, resulting in inexpensive operation.



The integrated emergency release allows the motor carriage to be engaged or disengaged in any position, and for emergency egress in event of power failure.



Intelligent control technology - self learning, adapting required force to external conditions for reliable operation



Integrated LED lighting is equipped with 6 individual LED's, ensuring optimum lighting during garage door travel



In the event of power failure, the operator can be run in emergency mode with an optional backup battery (Accu)



Universal with various door types, suited for sectional doors, overhead doors, up-and-over doors, side-opening sectional doors etc.

CHOOSE YOUR OPERATOR:

Residential



base+



- Residential Application
- Roof Mounted Control Unit

Sommer's Base+ operator is the perfect, cost effective solution for when a GPO is most accessible on the ceiling



pro+



- Residential Application
- Separate control unit that can be installed on the ceiling or wall
- Integrated open/close buttons on the control unit for convenience
- Enables easy transition when replacing a roller door with a sectional door

Both the Base+ and Pro+ models feature three models, each equipped with motors of varying power in order to meet diverse application requirements

Type	S 9060 (Base+ only)	S 9080	S 9110
Max Door Weight	120KG	160KG	200KG
Max Speed	240mm per sec	210mm per sec	180mm per sec
Max Pull/Push Force	600N	800N	1100N
Sectional Door - Max Door Width	4500mm	6000mm	8000mm
Sectional Door - Max Door Height	2500mm	2500mm	2500mm

SOMMER base+

Residential Applications | The Intelligent Operator



The base+ is SOMMER's advanced garage door control unit with various optimised speed profiles and the option of precision setting of the operating forces. The system continuously learns automatically and adjusts the door operation accordingly.

Top Quality & Maximum Safety:

- Intelligent, responsive control technology
- Low wear and robust build
- Powerful traveling motor
- Extremely low power consumption
- Partial opening options
- Light control with LED lighting in traveling operator
- Forced entry detection, generating counter-pressure with high self-locking force during vandal attempts

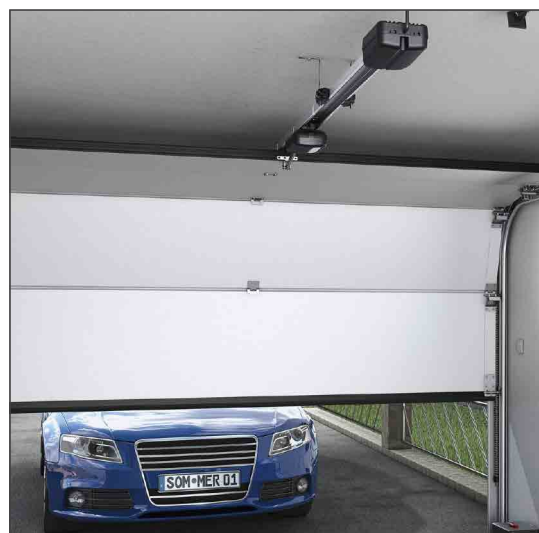

Residential



Roof Mounted
GPO

SOMMER pro+

Residential Applications | The Intelligent Operator With Separately Mounted Control Unit



-  Side Opening Sectional Doors
-  Sectional Door
-  One Piece Door
-  Up-and-over Door
-  Integrated LED Lighting
-  Optional Backup Battery
-  SOMlink Supported
-  <1W Standby

Integrated Open/Close buttons



The SOMMER pro+ combines our advanced garage door control unit with the flexibility of a separate control unit housing, which can be installed on the wall or ceiling (meaning existing sockets can be used). The control unit also includes an integrated button for additional convenience when triggering the garage door.

Incorporating all the same benefits of the base+ operator with...

- A separate control unit that can be installed on the wall or ceiling
- Integrated open/close buttons on the control unit for added convenience



Residential



Wall Mounted
GPO

CHOOSE YOUR OPERATOR: Condominium

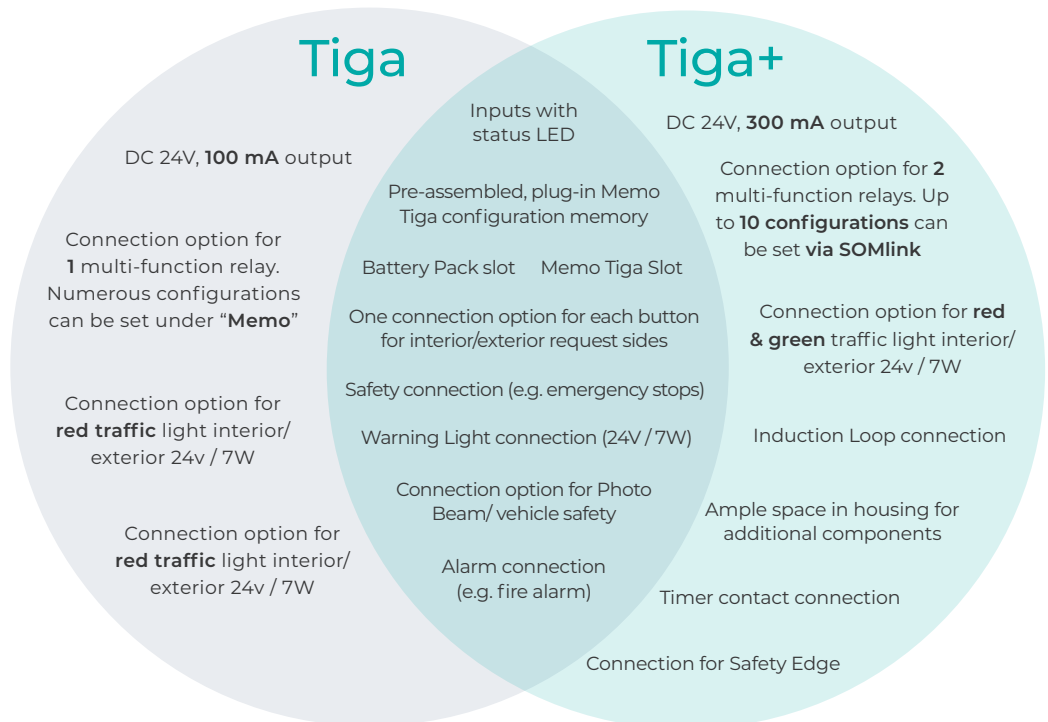

Type	S 9080 (Tiga only)	S 9110 (Tiga & Tiga+)
Max Door Weight	160KG	200KG
Max Speed	210mm per sec	180mm per sec
Max Pull/Push Force	800N	1100N
Sectional Door - Max Door Width	6000mm	8000mm
Sectional Door - Max Door Height	2500mm	2500mm

SOMMER Tiga & Tiga+

Condominium Applications | The Reliable Operator for Underground or Condominium Garages



The Tiga/Tiga+ is SOMMER's advanced garage door control unit for group and underground garages. These operators are optimised for frequent usage, extremely durable and long lasting, while still offering easy installation and adjustment, satisfying both users and installers.

Top Quality & Maximum Safety:

- Intelligent, responsive control technology
- Low wear and robust build
- Powerful traveling motor
- Extremely low power consumption
- Partial opening options
- LED lighting in traveling operator
- Break in detection, generating counter-pressure with high self-locking during attempts



Type	S 9080	S 9110
Tiga	#1981-0015	#1981-0017
Tiga+	N/A	#1981-0016



Handheld **TRANSMITTERS**

SOMMER



PEARL STATUS

3-command handheld transmitter with noticeable feedback of radio commands via vibration. Option of querying door position and receiver status without travel motion. Approx range 50 - 150m

#1018-0160



PEARL 2 BUTTON
#1018-0093

PEARL TWIN+ 2 BUTTON
#1018-0160

SOMloq2 compatible, suited for high volume user management through the use of the Codemaster+



PEARL 4 BUTTON
#1018-0092

PEARL VIBE 4 BUTTON
#1018-0123

SOMloq2 compatible, suited for high volume user management through the use of the Codemaster+



SLIDE VIBE 4 BUTTON TRANSMITTER
#1018-0192

- *SOMloq2 compatible, suited for high volume user management through the use of the Codemaster+*

- *Bi-Directional technology allows the remote to vibrate and light up, confirming that the automation has received the signal from the remote*

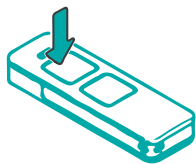

Hold for 3 seconds



Transmitter repeats for 15 secs



Gate automatically opens when within range



SOMCOM 2 Channel Add-on Receiver

#1018-0094



Pearl Transmitter Car & Wall Holder Clip

#6049-0509



Pearl Transmitter Sun-visor Clip

#6049-0510



Codemaster+ (manage transmitters remotely)

#6049-0573

Manage transmitters remotely, great for body corp or high use premises



Memo Memory Expansion Chip

#1018-0097

Stores up to 450 signals

POPULAR ACCESSORIES

SOMweb

Enables the user to control multiple garage door operators via a smartphone app or web browser



INTEGRATED SERVER. ALL DATA IS STORED ON THE SOMweb AND NOT ON EXTERNAL SERVERS



LIMIT ACCESS FOR USERS BY WEEK, PER DAY OR BY THE EXACT HOUR



SPECIFY WHICH USER CAN OPERATE WHICH DOOR



SPECIFY WHETHER THE USER ONLY HAS ACCESS WITHIN THE LOCAL NETWORK OR ALSO VIA INTERNET



THE CALENDAR SHOWS YOU WHEN A DOOR WAS OPENED AND BY WHOM

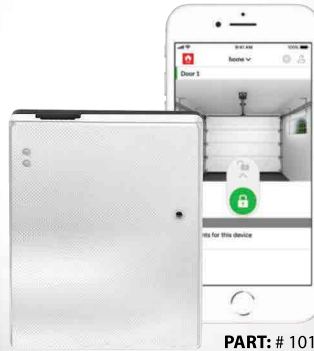

PART: # 1018-0131



OPTIONAL VIDEO FUNCTION VIA BOOKABLE VIDEO PLUG-IN



SOMweb IP Cameras + Video Plugin

Watch your garage or gate open and close



IP CAMERA VIDEO FEATURE CAN BE TRIALED FOR FREE FOR A DURATION OF 30 DAYS



THE PURCHASE OF 3 YEAR LICENSES IS REQUIRED TO OPERATE IP CAMERAS ON THE SOMWEB APP ONGOING



COMPATIBLE IP CAMERAS ARE PURCHASED SEPARATELY TO THE SOMWEB AND VIDEO PLUGIN SOFTWARE LICENCE



PART: # 6049-0517



PART: # 6049-0518



SOMlink

Programming interface of some SOMMER gate automation products via the SOMLink web application



What is SOMloq2 Technology?

For maximum convenience, SOMMER offer the corresponding radio products for all modules. The range consists of transmitters and keypads, including a variety of 2 channel and 4 channel transmitters.

Features include:

- Added convenience through range of accessories
- Increased security
- Status queries of the door to auto repeat and hop functions
- Surface or flush mount keypads available
- 'Pearl Vibe' transmitter offers feedback of radio commands via vibration

POPULAR ACCESSORIES

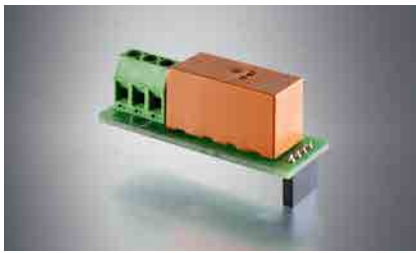

Relay

#6049-0524

For activating external lighting or querying the door status "Door closed"/ "Door not closed".

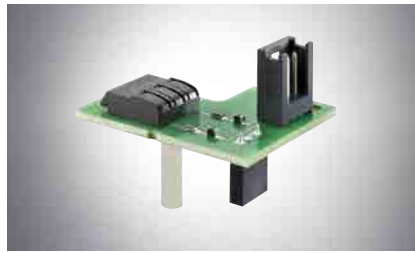

Conex - Circuit Board

#6049-0513

Allows the connection for dedicated open and close inputs. Suitable for connection to fire control panel

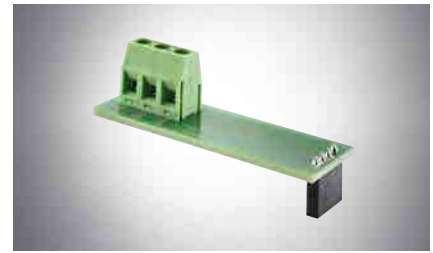

Output OC

#6049-0514

Transfers the status (open/closed) to Smart Home systems. Optionally, a further external lighting unit with 24V can be operated



Humidity Sensor

#6049-0680

Records temperature and air humidity in the garage, ensuring perfect circulation & reduce mould risk. The door will automatically partially open as required, then close when optimal value is reached.



Parking Position Laser

#6049-0523

Laser parking position laser ensures precise parking in the garage, even without a parking assist system.



Motion Detector

#6049-0525

The operator lighting is automatically switched on in the motor carriage when movement is detected in the garage.



Buzzer

#6049-0522

The alarm buzzer recognises break-in attempts and outputs a loud signal. The warning buzzer on the other hand, outputs an acoustic signal during the closing process or when the wicket door is open.



Lumi +

#6049-0520

Additional LED lighting for the Base+ operators.

Lumi Pro+

#6049-0521

Additional LED lighting for the Pro+ operators.



Magnetic Lock

#6049-0519

Magnetic motor lock which mechanically blocks the motor in any position up to an attack force of 300 kg, thereby improving the existing break-in protection.

POPULAR ACCESSORIES



Accu - Emergency Battery
#6049-0516

Provides emergency power supply to the operator for 12 hours and 5 door cycles in the event of a power failure



ACCU 2.2 - Emergency Battery

Provides emergency power supply to the operator for up to 36 hours and 75 door cycles. Separate enclosure (322 x 105 x 105 mm)



Low Headroom Bracket Set
#6049-0630

Special fitting for low height or torsion spring at the rear. Reduces the distance from the motor carriage to the door leaf by approximately 24cm



Sectional Door Fitting (without boomerang)
#6049-0572

Adjustable for doors with double rail

Sectional Door Fitting (with boomerang)
#6049-0633

Sectional door boomerang



Emergency External Release Lock
#6049-0631

Emergency External Release Lock (master key). 13mm standard key, length 50mm



543mm Rail Extension set
#6049-0634

1096mm Rail Extension Set
#6049-0629

Track extension set for high doors (543mm). Set includes a ceiling bracket, insulator chain, connecting sleeve and magnet



LZR - Vertical Curtain Sensor
#5159-0004

9m x 9m max curtain

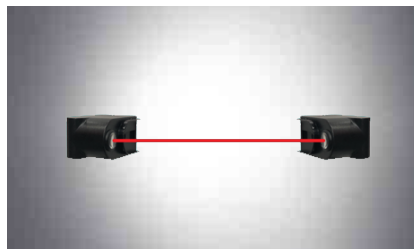

ARMAS No Touch 2 Safety Beam (Hardwired)
#1059-0041

8m optical range



ARMAS Fixed Lens Photo Beams
#1059-0043

15m range

ARMAS Fixed Lens Photo Beams
#1059-0042
40m range

POPULAR ACCESSORIES



Telecodey+ Keypad

#1018-0124

50m max range



Entracode+ Surface Mounted Keypad

#1038-0016

25m max range



Entrasys+ Surface Mounted Finger Scanner

#1038-0021

- Up to 80 fingerprints

- 25m max range



Entracode+ Flush Mounted Keypad

#1038-0017

50m max range



Entracode+ Flush Mounted Wired Keypad

#1038-0015

25m max range



Entrasys+ Universal Mount Semi-Wireless Finger Scanner

#1038-0019

- Up to 80 fingerprints

- 25m max range



Entrasys+ Flush Mount Semi-Wireless Finger Scanner

#1038-0020

25m max range





Sectional door



Side-opening sectional door



One piece door



Up-and-over door



Hinged double door

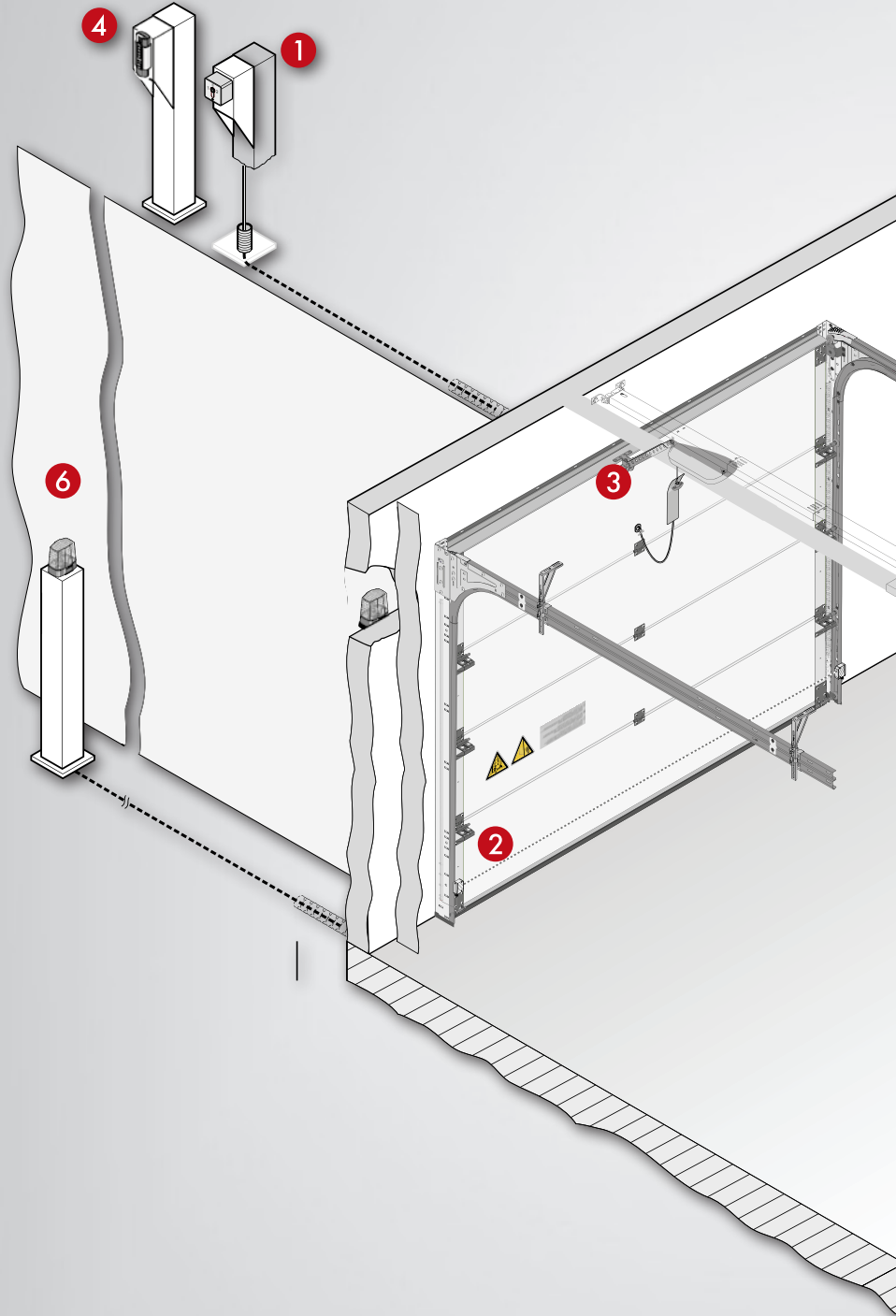

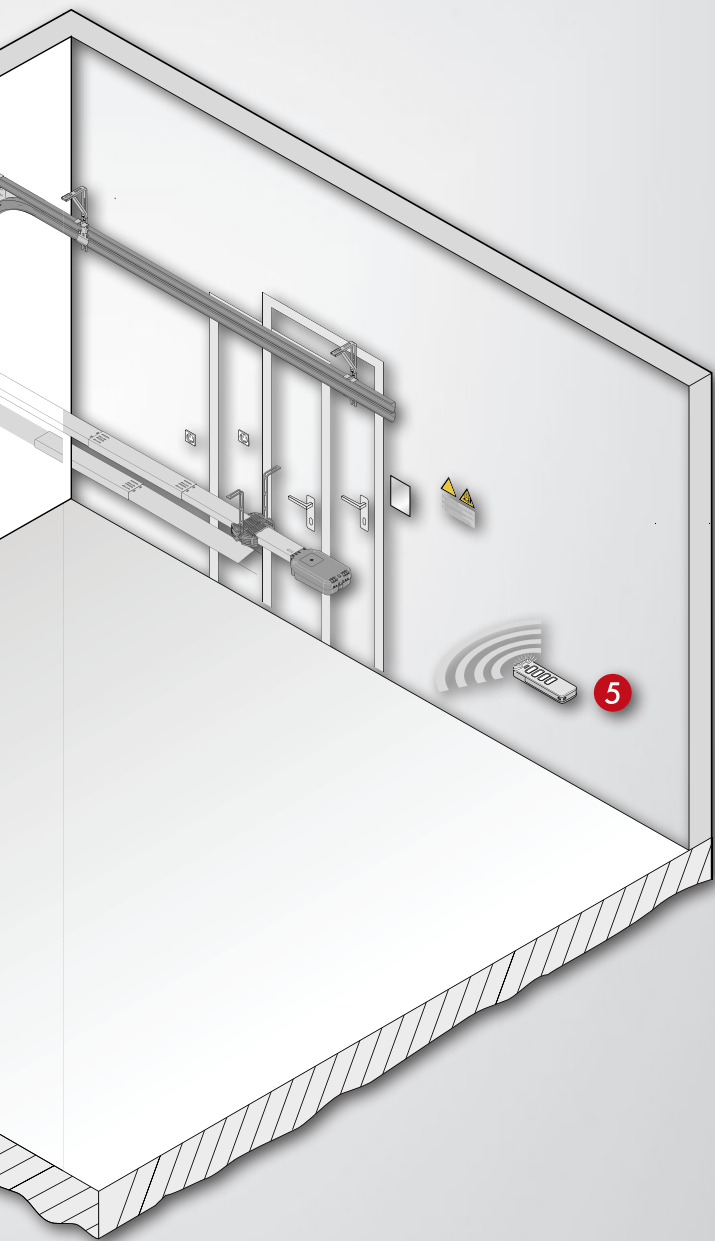

1 FINGER SCANNER
Activate the garage door via the fingerprint of an authorised user

2 PHOTO CELLS
Obstacle detection via the interception of a light beam, preventing the door from closing



3 EMERGENCY RELEASE LOCK
For fast & safe emergency release in the event of a power outage

4 KEYPAD
Operate your garage door via entering a set code

5 HANDHELD TRANSMITTER
For convenient operation of the garage or building doors, and for switching a light on/off

6 WARNING LIGHT
For additional optical hazard detection



 1300 366 046
 sales@global-access.com.au

Visit our website!
[Global-access.com.au](https://www.global-access.com.au)

